

D.O.O. STEGNE 35 1000 LJUBLJANA SLOVENIJA

tack@tack.si ; www.tack.si; T ++ 386 (0)1 620 98 00 – gsm: ++ 386 (0)40 78 00 10 ; 041 691 517

V sodelovanju kot POOBlašČeni ZASTOPNIK za področje: SL; HR; BiH; SRB; MC; CG; KOS



# MAK-SAY

## STROJI – PNEUMATSKO KLADIVO

SPH - 50 - 60 - 75 - 100

### Pnevmatsko kovanje KLADIVO

- Varjena jeklena konstrukcija
- Redni udarci s ventilom za prilagoditve
- Vsa orodja in sal blok (SPREJEMNI BLOK) sta zamenljiva, sal blok nastavljiv v 8 smereh
- Nastavljiv Sal blok za delovni koto operaterja
- Enostaven in funkcionalen sistem za mazanje
- Nastavljiv pedal glede na delovno ravan , foto pedal s zaščito jeklenim pokrovom.
- jeklena osnova ali leseno podlago (po želji)
- zgradili v skladu z direktivami o varnosti CE

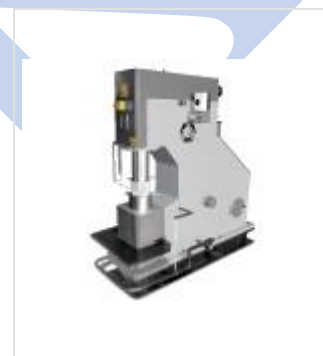
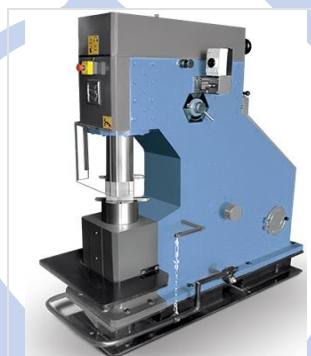

### Tehnična Tabela

### TEHNIČKI PODATCI

TEHNIČNI PODATKI	SPH 50	SPH 60	SPH 75
Operacijski sistem / <b>POGON</b>	Pnevmatski	Pnevmatski	Pnevmatski
Nominalna Teža moči / <b>SNAGA</b>	50 kg	60 Kgs	75 Kgs
Zadetkov na minuto / <b>UDARACA u min</b>	240	220	210
Najvišja višina / <b>VISINA UDARCA</b>	185 mm	220 mm	220 mm
Moč motorja / <b>SNAGA MOTORA</b>	4 kw	7,5 kw	7,5 kw
Motor vrtljajev / min. / <b>OKRETA u min.</b>	1450	1450	1450
Delovna površina / <b>RADNA POVRŠINA</b>	150 x 78 mm	150 x 78 mm	150 x 78 mm
Približna teža / <b>TEŽINA STROJA</b>	1000 Kg	1300 Kg	1600 Kg
Nakovalo Teža / <b>TEŽINA NAKOVNJA</b>	300 kg	355 kg	430 Kg
Širina ( ) / <b>ŠIRINA STROJA</b>	730 mm	760 mm	820 mm
Dolžina (B) / <b>DUŽINA STROJA</b>	1750 mm	1840 mm	1950 mm
Višina (C) / <b>VISINA STROJA</b>	1450 mm	1680 mm	1800 mm

## Pneumatsko kovanje - ČEKI

- Varena čelična konstrukcija
- Konstantni udarci sa ventilom za prilagođavanje
- Sve alate i sal blok (PRIJEMNI BLOK) je zamjenljiv, sa blokom nastavaka u 8 smjerova
- Nastavljiv Sal blok sa radnim kutom operatera
- Jednostaven in funkcionalan sistem za podmazivanje
- Nastavljiva pedala u odnosu na radnu visinu, foot pedal sa čeličnom zaštitom
- Čelična osnova ili drvena podlaga (po želji) za nakovanj
- Napravljeni u skladu sa direktivama o sigurnosti CE-normama



**ORODJE PO NAROČILU za PNEVMATSKA KLADIVA :**

**ALATI PO NARUDŽBI ZA PNEUMATSKE ČEKIČE :**

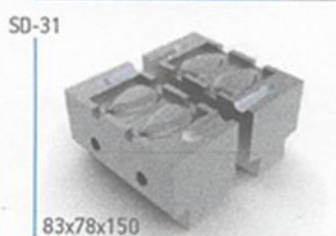
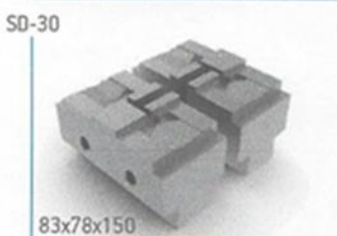
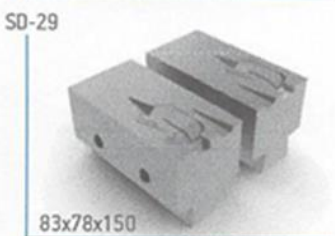
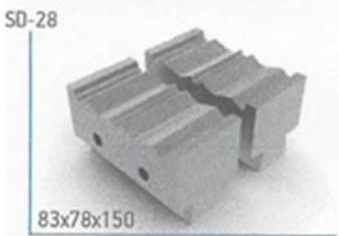
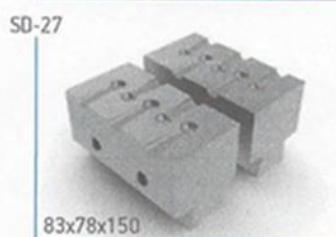
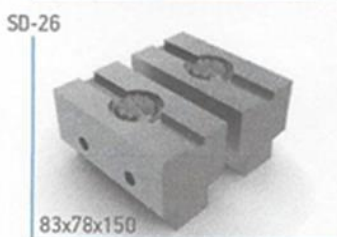
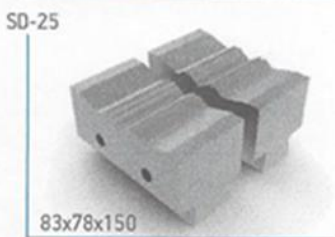
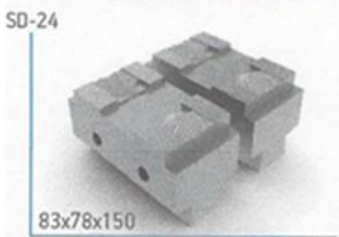
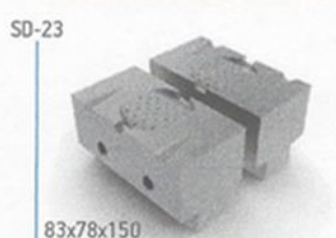
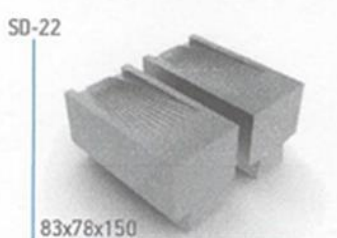
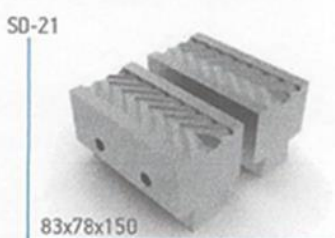
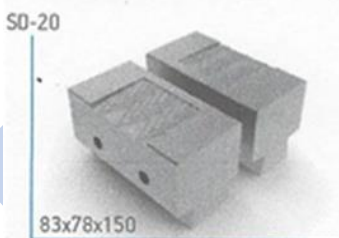
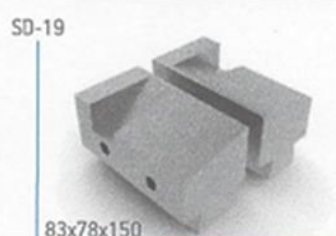
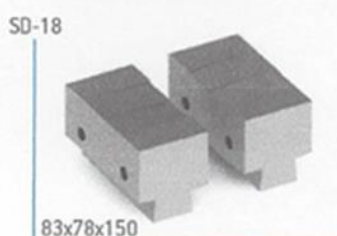
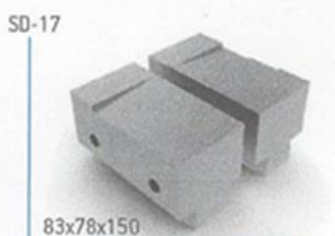
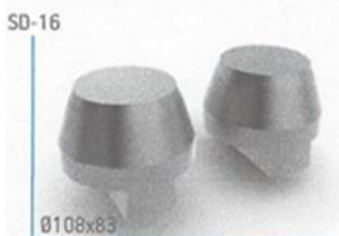
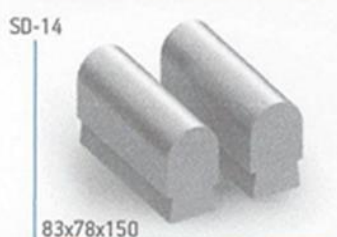
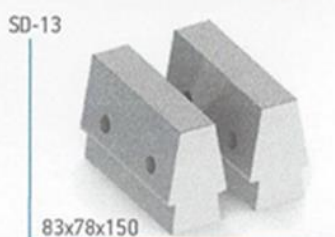
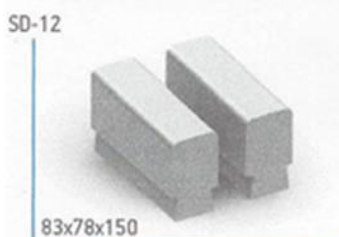
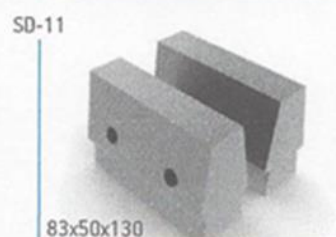
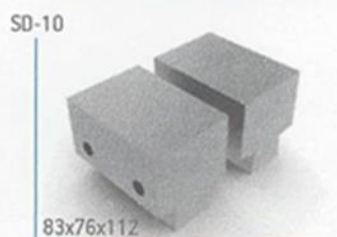
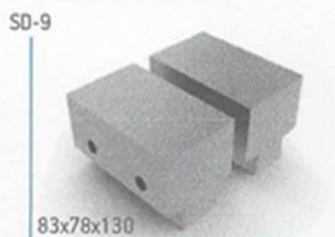
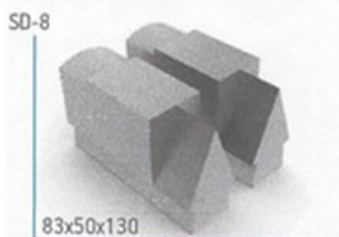
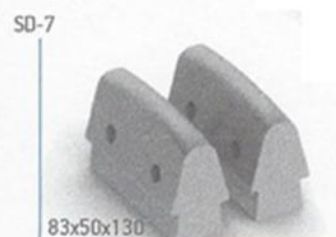
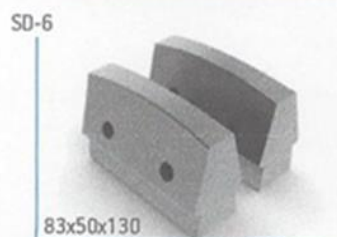
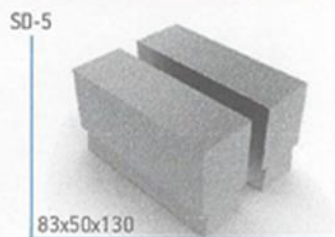
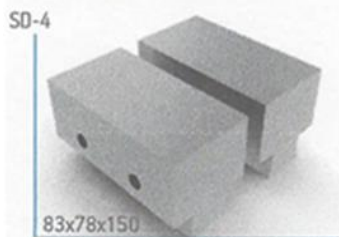
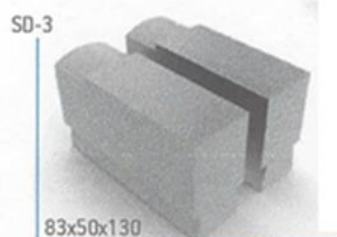
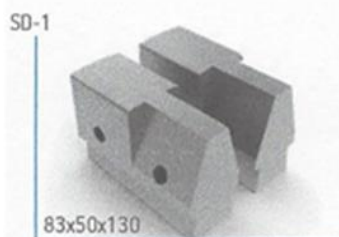

POOBLAŠČENI ZASTOPSTVO za PODROČJE EX YU :



# TACK d.o.o.

Stegne 35; SLOVENIJA Tel./ Fax:+386 (0)1 620 98 00  
gsm:040 78 00 10 in 041/691 517  
[tack@tack.si](mailto:tack@tack.si) ; [info@tack.si](mailto:info@tack.si) ; [www.tack.si](http://www.tack.si)



2020 - 2021 - 2022

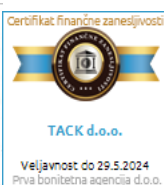

Pooblašteni zastopniki za EX YU države od strani TACK d.o.o. :



ZASTUPNIK u BiH: »**HIDROMETAL**« Banja Luka i **SMR-ELECTRONICS** Gradačac  
Predstavnik Sarajevo



ZASTUPNIK za Crnu Goru : »**HIDROMETAL**« Banja Luka i **SMR-ELECTRONICS** Gradačac  
Predstavnik Bar



ZASTUPNIK u HRVATSKOJ : „**DURHES**“ Bjelovar i **MT SOLUTIONS & TECHNOLOGY d.o.o. ZG**



ZASTUPNIK U SRBIJI : **SMT Solutions & Technology** d.o.o. Beograd